

Si PIN photodiode

S5106, S5107, S7509, S7510

Chip carrier package for surface mount

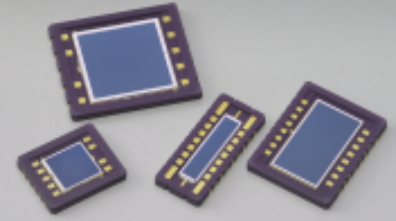

S5106, S5107, S7509 and S7510 are Si PIN photodiodes sealed in chip carrier packages suitable for surface mount using automated solder reflow techniques. These photodiodes have large active areas, making them suitable for spatial light transmission where a wide field-of-view angle is required. Other applications include POS scanners, power meters and analytical instruments.

Features

- Active area
S5106: 5 × 5 mm
S5107: 10 × 10 mm
S7509: 2 × 10 mm
S7510: 6 × 11 mm
- Ceramic chip carrier package for surface mount
- Suitable for solder reflow
- High sensitivity

Applications

- Spatial light transmission
- Laser radar
- Power meter
- Bar-code reader

General ratings / Absolute maximum ratings

Type No.	Dimensional outline/ Window material *	Active area size (mm)	Effective active area (mm ²)	Absolute maximum ratings			
				Reverse voltage VR Max (V)	Power dissipation P (mW)	Operating temperature Topr (°C)	Storage temperature Tstg (°C)
S5106	①/R	5 × 5	25	30	50	-40 to +100	-40 to +125
S5107	②/R	10 × 10	100				
S7509	③/R	2 × 10	20				
S7510	④/R	6 × 11	66				

Electrical and optical characteristics (Typ. Ta=25 °C, unless otherwise noted)

Type No.	Spectral response range λ (nm)	Peak sensitivity wavelength λ_p (nm)	Photo sensitivity S (A/W)				Short circuit current Isc 100 lx (μ A)	Dark current ID VR=10 V		Temp. coefficient of ID TCID (times/°C)	Cut-off frequency fc RL=50 Ω VR=10 V (MHz)	Terminal capacitance Ct f=1 MHz VR=10 V (pF)	NEP VR=10 V $\lambda=\lambda_p$ (W/Hz ^{1/2})
			λ_p	660 nm	780 nm	830 nm		Typ.	Max.				
S5106	320 to 1100	960	0.72	0.45	0.57	0.62	27	0.4	5	1.15	20	40	1.6×10^{-14}
S5107							110	0.9	10		10	150	2.4×10^{-14}
S7509							22	0.5	5		20	40	1.7×10^{-14}
S7510							72	1.0	10		15	80	2.5×10^{-14}

* Window R: Resin coating

Note) S5106, S7509: For mass production, order unit is 100 pieces.
S5107, S7510: For mass production, order unit is 50 pieces.

■ Spectral response

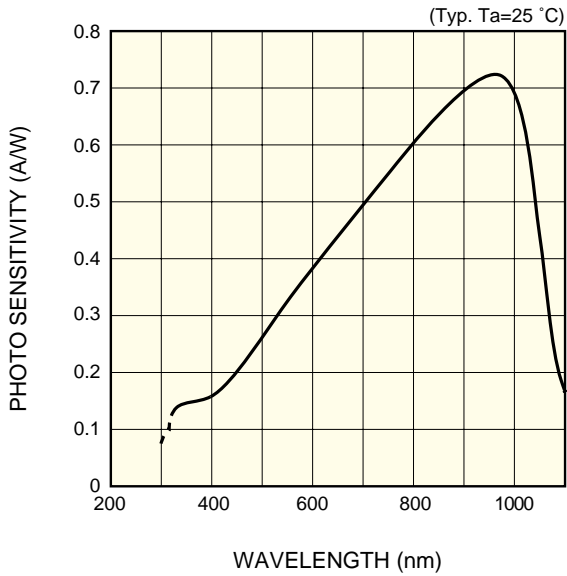

KPINB0165EA

■ Photo sensitivity temperature characteristic

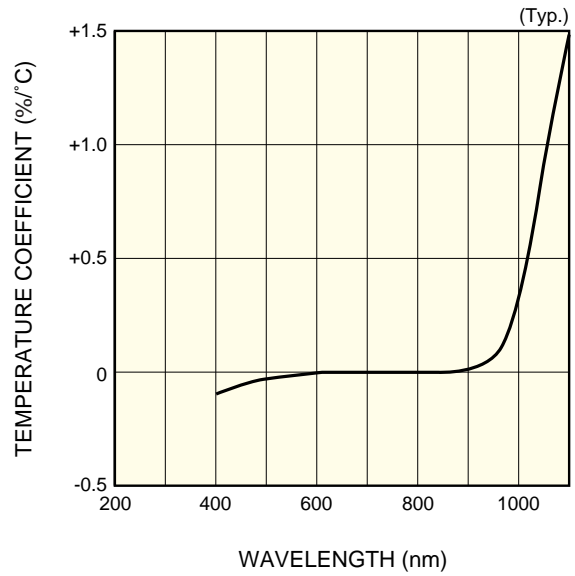

KPINB0093EC

■ Dark current vs. reverse voltage

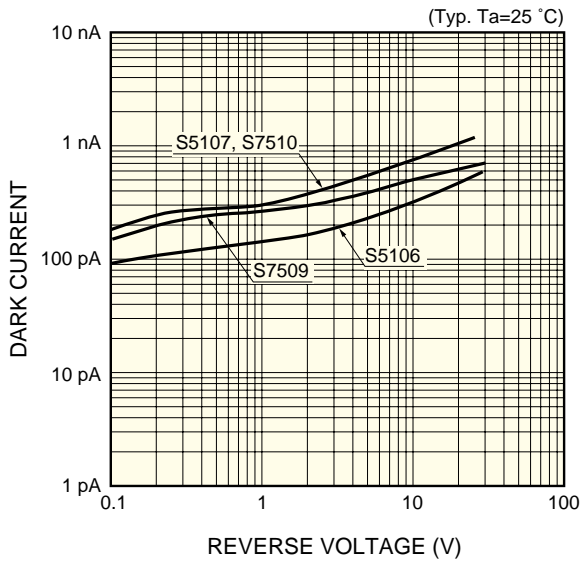

KPINB0166EA

■ Terminal capacitance vs. reverse voltage

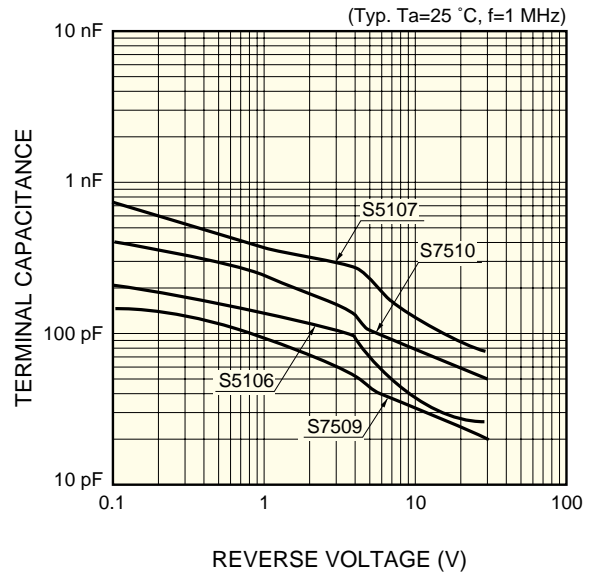

KPINB0128EA

■ Dimensional outlines (unit: mm)

① S5106

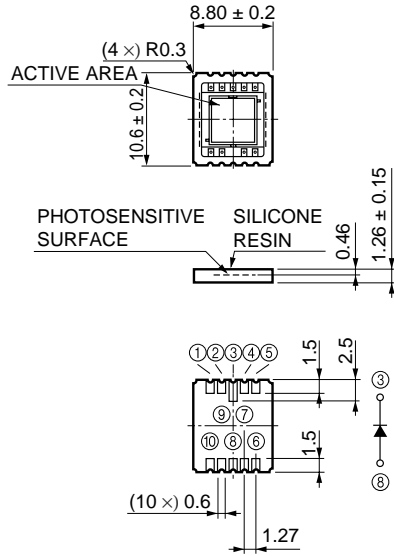

NC (excluding pins ③⑥)
Burs shall protrude no more than 0.3 mm on any side of package.

KPINA002EE

② S5107

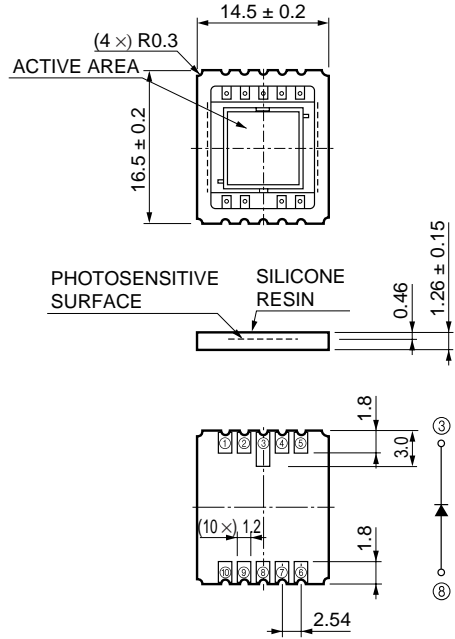

NC (excluding pins ③⑧)
Burs shall protrude no more than 0.3 mm on any side of package.

KPINA0013EC

③ S7509

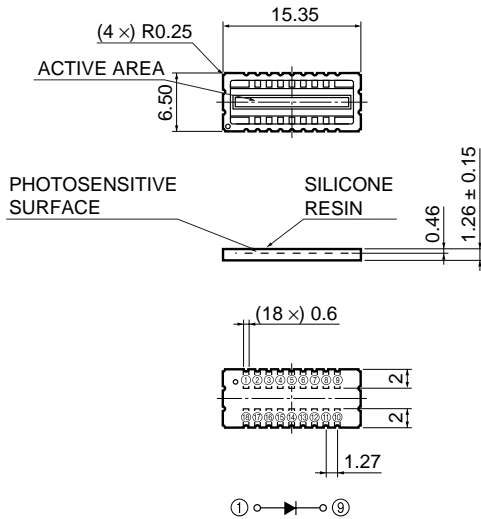

NC (excluding pins ①⑨)
Burs shall protrude no more than 0.3 mm on any side of package.

KPINA0055EB

④ S7510

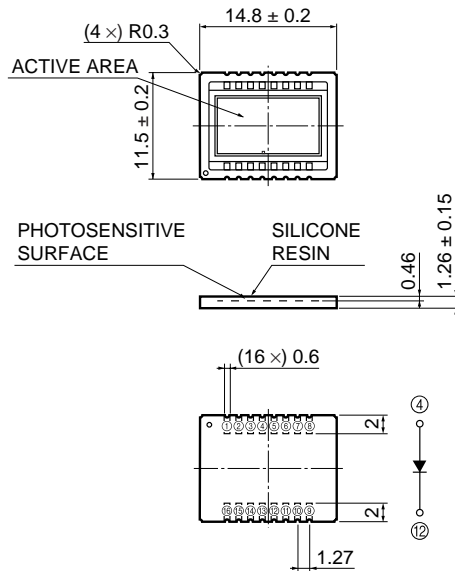

NC (excluding pins ④⑫)
Burs shall protrude no more than 0.3 mm on any side of package.

KPINA0066EB

Precautions for use

- The light input window of this product uses soft silicone resin. Avoid touching the window to keep it from grime and damage that can decrease sensitivity. External force applied to the resin surface may deform or cut off the wires, so do not touch the window to prevent such troubles.
- Use rosin flux when soldering, to prevent the terminal lead corrosion. Reflow oven temperature should be at 260 °C maximum for 5 seconds maximum time under the conditions that no moisture absorption occurs.
Reflow soldering conditions differ depending on the type of PC board and reflow oven. Carefully check these conditions before use.
- Silicone resin swells when it absorbs organic solvent, so do not use any solvent other than alcohol.
- Avoid unpacking until you actually use this product to prevent the terminals from oxidation and dust deposits or the coated resin from absorbing moisture.
When the product is stored for 3 months while not unpacked or 24 hours have elapsed after unpacking, perform baking in nitrogen atmosphere at 150 °C for 3 to 5 hours or at 120 °C for 12 to 15 hours before use.

HAMAMATSU

Information furnished by HAMAMATSU is believed to be reliable. However, no responsibility is assumed for possible inaccuracies or omissions. Specifications are subject to change without notice. No patent rights are granted to any of the circuits described herein. ©2006 Hamamatsu Photonics K.K.

HAMAMATSU PHOTONICS K.K., Solid State Division

1126-1 Ichino-cho, Higashi-ku, Hamamatsu City, 435-8558 Japan, Telephone: (81) 53-434-3311, Fax: (81) 53-434-5184, www.hamamatsu.com

U.S.A.: Hamamatsu Corporation: 360 Foothill Road, P.O.Box 6910, Bridgewater, N.J. 08807-0910, U.S.A., Telephone: (1) 908-231-0960, Fax: (1) 908-231-1218

Germany: Hamamatsu Photonics Deutschland GmbH: Arzbergerstr. 10, D-82211 Herrsching am Ammersee, Germany, Telephone: (49) 08152-3750, Fax: (49) 08152-2658

France: Hamamatsu Photonics France S.A.R.L.: 19, Rue du Saule Trapu, Parc du Moulin de Massy, 91882 Massy Cedex, France, Telephone: 33-(1) 69 53 71 00, Fax: 33-(1) 69 53 71 10

United Kingdom: Hamamatsu Photonics UK Limited: 2 Howard Court, 10 Tewin Road, Welwyn Garden City, Hertfordshire AL7 1BW, United Kingdom, Telephone: (44) 1707-294888, Fax: (44) 1707-325777

North Europe: Hamamatsu Photonics Norden AB: Smidesvägen 12, SE-171 41 Solna, Sweden, Telephone: (46) 8-509-031-00, Fax: (46) 8-509-031-01

Italy: Hamamatsu Photonics Italia S.R.L.: Strada della Moia, 1/E, 20020 Arese, (Milano), Italy, Telephone: (39) 02-935-81-733, Fax: (39) 02-935-81-741